

HELLAS - KRETA

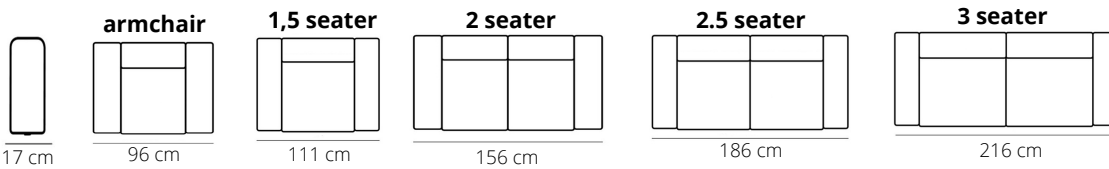

ELEMENTS

Sizes with small arm



Sizes with wide arm

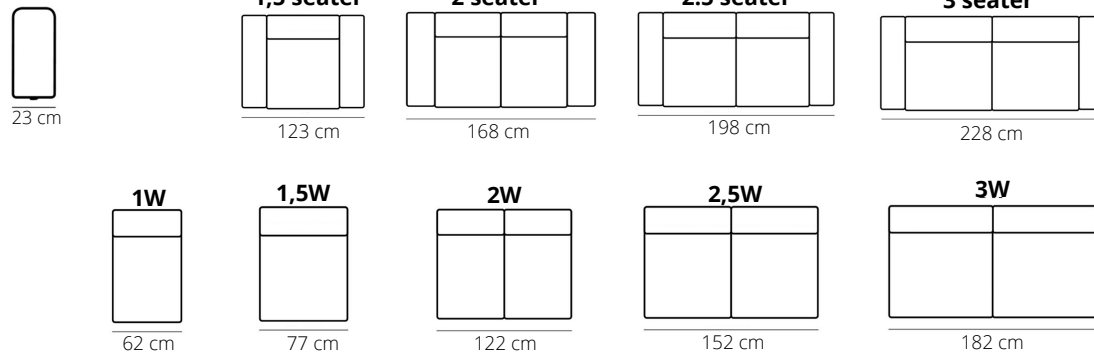

AL-LK (arm left) LK-AR (arm right) AL-LG (arm left) LG-AR (arm right)

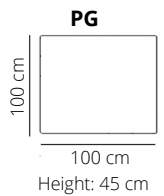
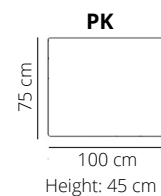
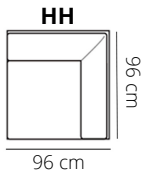
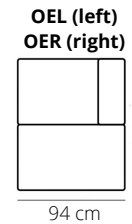
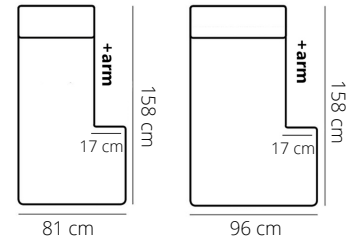

STITCHING

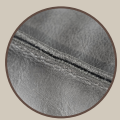

open seam

HELLAS

only available in leather or L60 oklakoma/Colorado and fabrics Hunter



pinched seam

KRETA

available in leather and fabrics

LEGS



J-127
black

HEIGHT: 77 cm
DEPTH: 94 cm
SEAT DEPTH: 57 cm
SEAT HEIGHT: 45 cm
ARM HEIGHT: 60 cm

PRODUCT INFO

FRAME



beechwood



chipboard

FILLING

BACK



foam SG 28



fibre wool



elastic belts

SEAT

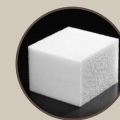

foam SG 40



fibre wool



no-sag springs

Caution: with the use of different moulds, the stitchery of models in fabrics can be different from the stitchery of the same models in leather.
All sizes are approximate, technical and stylistic changes and typing errors are reserved.